

Data Sheet

4-Way Reversing valves Type **STF** and **STF-H**

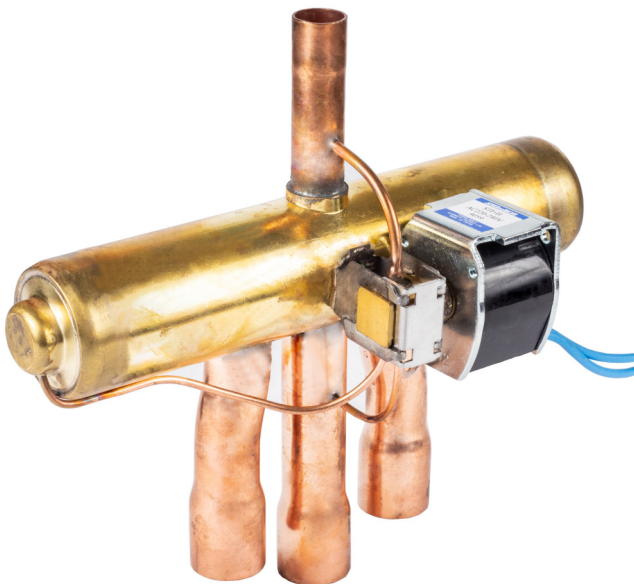

The 4-way valves are used in reversible applications such as heat pumps or reversible air conditioning units and chillers.

The 4-way valve allows an inversion of the refrigeration cycle, changing from cooling mode in summer to heating mode in winter.

Features

- Wide application range
 - complete capacity range
 - available for all common refrigerants including flammable refrigerants)
 - many different connection diameters and configurations
- High reliability
 - unique design
 - instantaneous changeover at minimum pressure differential
 - mechanism to prevent incomplete changeover
 - Minimized leakage
- CE approved
- UL approved

Application

The cycle inversion is initiated by a small solenoid pilot valve, which pilots the movement of a slider, which changes the direction of the refrigerant. The valve is connected to the discharge and suction pipes.

The pilot valve ensures a very reliable changeover from cooling to heating mode, the changeover happens instantaneously with a minimum pressure differential. The valve design also guarantees a minimum pressure drop and a very low risk of leakage.

Figure 1: HEATING CYCLE (Coil energized)

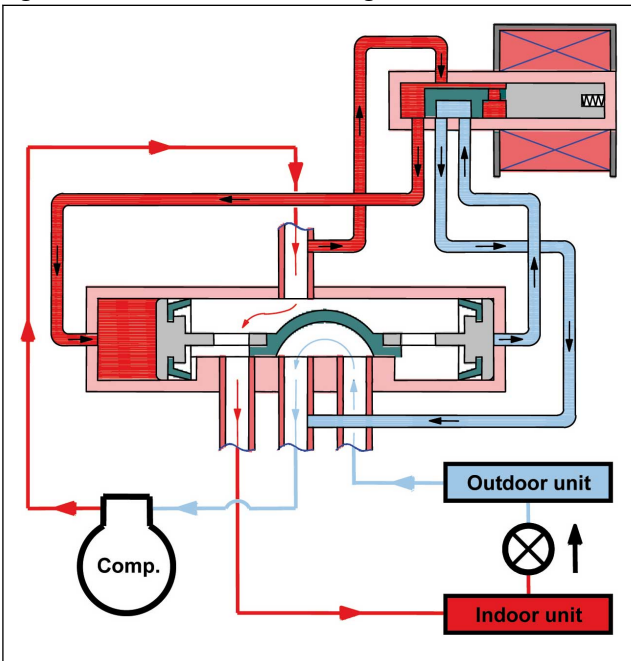
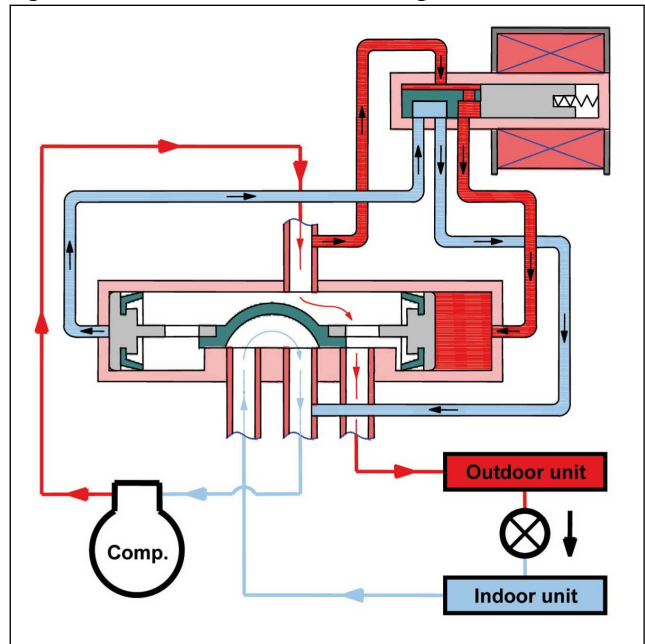

Figure 2: COOLING CYCLE (Coil not energized)



Product specification

Technical data

Table 1: Technical data

Parameter	STF and STF-H
Compatibility refrigerants	R22, R134a, R407A, R4070, R404A, R410A, R448A, R449A R32, R290, R454C, R454B, R452B (see safety note below)
Min. OPD	3 bar
Max. OPD	31 bar
Max. working pressure (PS/MWP)	45 bar Note! 49 bar for selected models. Please check Table 2: Ordering table for further information.
Refrigerant temperature range	-30 to 130 °C Note! 160 °C for selected models. Please check Table 2: Ordering table for further information.
Ambient temperature	-30 to 55 °C

NOTE:

Special safety note for flammable refrigerants!

For countries where safety standards are not an indispensable part of the safety system Danfoss recommends the installer gets a third party approval of any system containing flammable refrigerant

Please refer to separate drawings of the STF and STF-H valves with special disclaimer regarding usage of flammable refrigerants. Please refer to separate document "Important Notice for usage of STF and STF-H valves with flammable refrigerants (No. S-FD001-3).

Design

Figure 3: Design

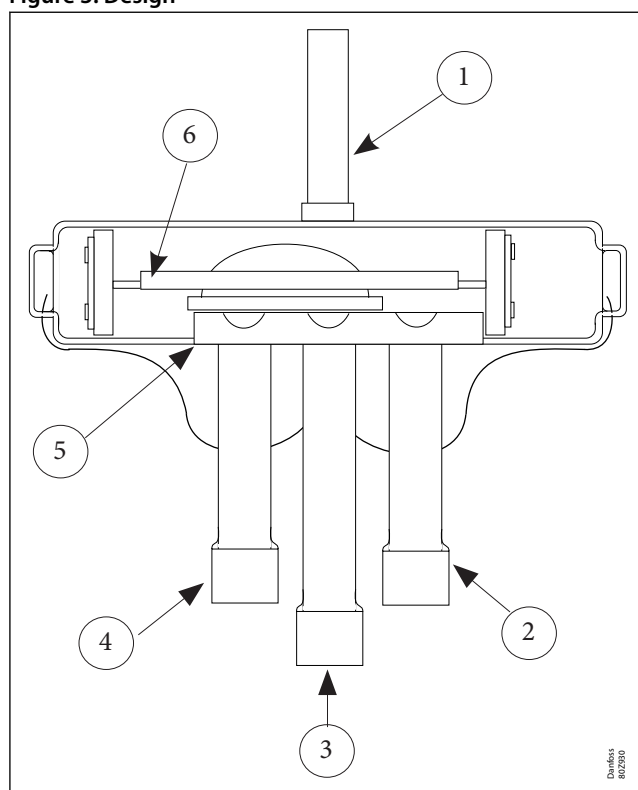

- | | |
|---|-------------------------------------|
| 1 | Discharge connection |
| 2 | Connection to evaporator/ condenser |
| 3 | Suction connection |
| 4 | Connection to condensor/ evaporator |
| 5 | Valve body |
| 6 | Slider |

The valve is composed of three basic components:

- Pilot valve
- Main valve body, including valve slider
- Solenoid coil

4-Way Reversing valves, Type STF and STF-H

The 4-way valve slider is shifted by changes in differential pressure in the valve which is actuated by the pilot solenoid valve. The valve slider is specially designed to prevent incomplete changeover and movement with minimum pressure differential.

Dimension

Refer to separate drawings of models. - Contact danfoss for further information.

Ordering

Table 2: Ordering

Model	Packing format	Danfoss code	Capacity [kW]	Style	Discharge	Suction	Media temperature	MWP	Approval
			⁽¹⁾ R290/R410A		[in]	[in]	[°C]	[bar]	
STF-H0167	45	061L1348	4.8	A	5/16	3/8	130	45	CE
STF-H0267	32	061L1349	9.5	A	3/8	1/2	130	45	CE
STF-H0321	32	061L1350	9.5	E	1/2	5/8	130	45	CE
STF-H0351	32	061L1351	13.7	B	1/2	5/8	130	45	CE
STF-H0429	24	061L1352	18.2	F	1/2	3/4	130	45	CE
STF-H0651	24	061L1353	25.1	B	1/2	3/4	130	45	CE
STF-H0731	6	061L1354	31.2	F	3/4	7/8	130	45	CE
STF-H0951	6	061L1355	38.12	B	3/4	7/8	160	49	CE
STF-H0954	6	061L1356	38.12	F	7/8	11/8	160	49	CE
STF-2028G	1	061L1357	41.8	F	11/8	13/8	160	49	CE
STF-2525G	1	061L1358	63.2	G	11/8	13/8	160	49	CE
STF-3015G	1	061L1345	89.4	G	11/8	15/8	160	49	CE
STF-4016G	1	061L1346	125.5	G	15/8	15/8	160	49	CE
STF-5017G	1	061L1360	161.3	G	15/8	2 1/2	160	49	CE
STF-6009G	1	061L1361	265.8	G	15/8	2 3/8	160	49	CE
STF-25U25G	1	061L1365	63.2	G	11/8	13/8	160	49	UL
STF-30U15G	1	061L1366	89.4	G	11/8	15/8	160	49	UL
STF-40U16G	1	061L1367	125.5	G	15/8	15/8	160	49	UL
STF-50U16G	1	061L1368	161.3	G	15/8	2 1/2	160	49	UL
STF-60U9G	1	061L1369	265.8	G	15/8	2 3/8	160	49	UL

⁽¹⁾ Capacity is indicated for 0.1bar suction pressure drop and condition 54.5 CCT, 7.2 CET and 5K SH

Table 3: Valve configuration

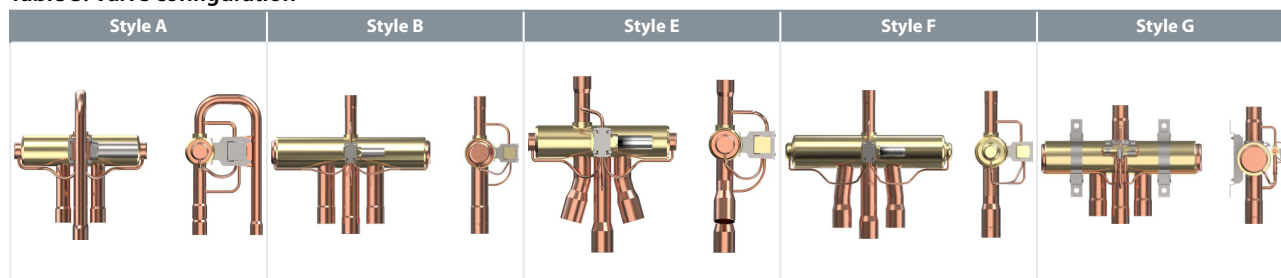

Coils for STF and STF-H valves

Table 4: Coil for STF valves

Model	Tambient	Supply voltage	Voltage variation	Frequency	Power consumption	Cable length	Code no.	Packing
	[°C]	[V]		[Hz]	[W]	[mm]		
STF-01AB500A1	-20T55	24	-15%, +10%	50/60	6/5	600	061L2092	I-pack 10 pcs
STF-01AB503B1	-20T55	24	-15%, +10%	50/60	6/5	1200	061L2038	I-pack 100 pcs
STF-01AJ504F1	-20T55	208-240	-15%, +10%	50	6	1200	061L2125	Single-pack 1 pc
STF-01AJ504F1	-20T55	208-240	-15%, +10%	50	6	1200	061L2094	I-pack 10 pcs
STF-01AJ504F1	-20T55	208-240	-15%, +10%	50	6	1200	061L2016	I-pack 100 pcs
STF-01AJ506B1	-20T55	220-240	-15%, +10%	50	6	600	061L2093	I-pack 10 pcs
STF-01AJ512D1	-20T55	220-240	-15%, +10%	50	6	2000	061L2095	I-pack 10 pcs
STF-01AJ512D1	-20T55	220-240	-15%, +10%	50	6	2000	061L2074	I-pack 60 pcs

4-Way Reversing valves, Type STF and STF-H

Table 5: Coil for STF-H valves

Model	Tambient	Supply voltage	Voltage variation	Frequency	Power consumption	Cable length	Code no.	Packing
	[°C]	[V]		[Hz]	[W]	[mm]		
STF-H01AJ1709A1	-20T50	220-240	-10%, +10%	50/60	6/5	600	061L2219	I-pack 100 pcs
STF-H01AJ1738A1	-20T50	220-240	-10%, +10%	50/60	6/5	2000	061L2220	I-pack 60 pcs

STF and STF-H coils - Model split:

- The old and new STF models uses the same coils.
- The old and new STF-H Models uses the same coils.
- For STF-H models we currently only have 2 coil versions with Danfoss codes.

NOTE:

Refer to drawings of specific models for detailed technical specifications and dimensions. Contact Danfoss for more information.

Capacity charts

Figure 4: STF capacity chart R134A

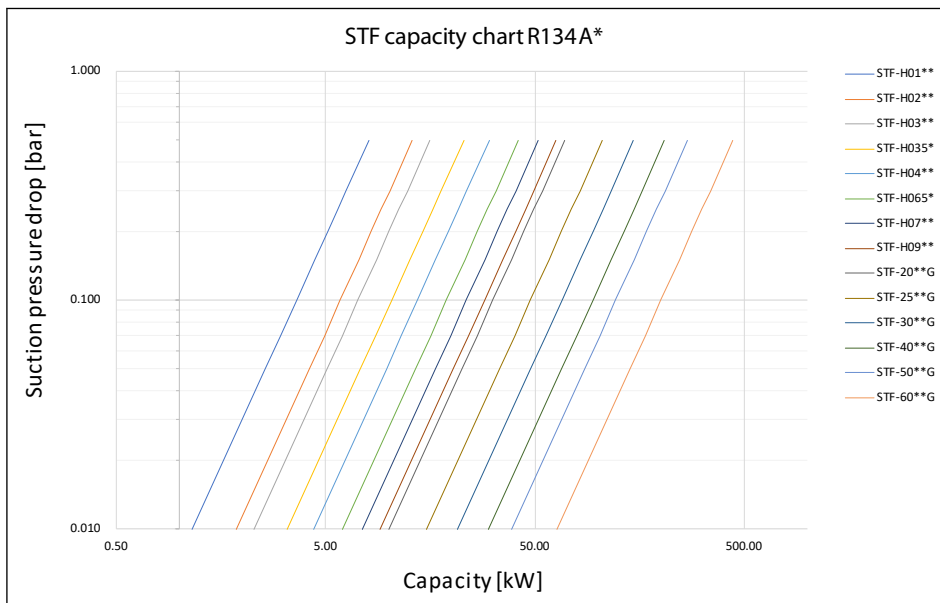

* Capacity calculated for CT 54.4 °C, ET 7.2 °C, SH 5K

Figure 5: STF capacity chart R404A

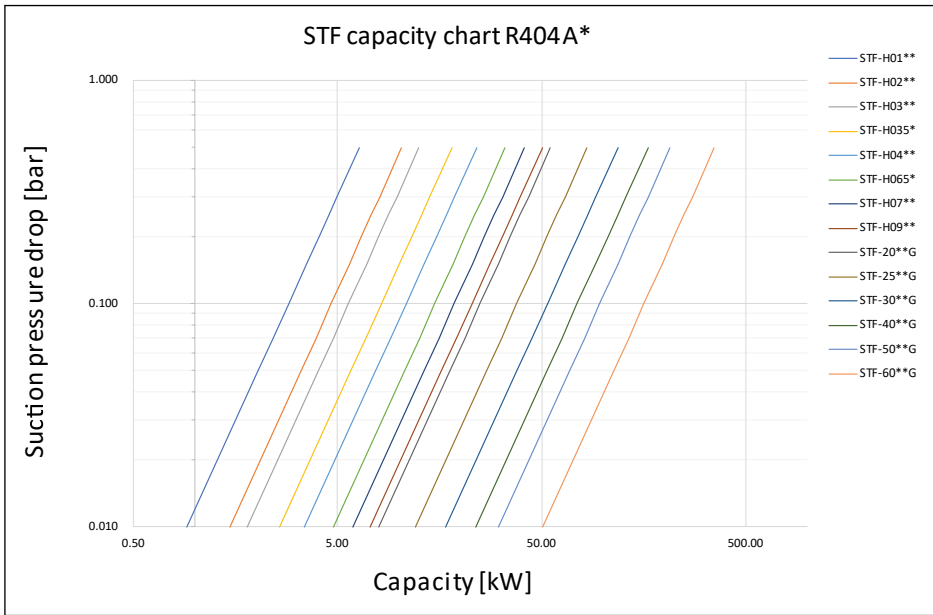

* Capacity calculated for CT 54.4 °C, ET 7.2 °C, SH 5K

Figure 6: STF capacity chart R407C

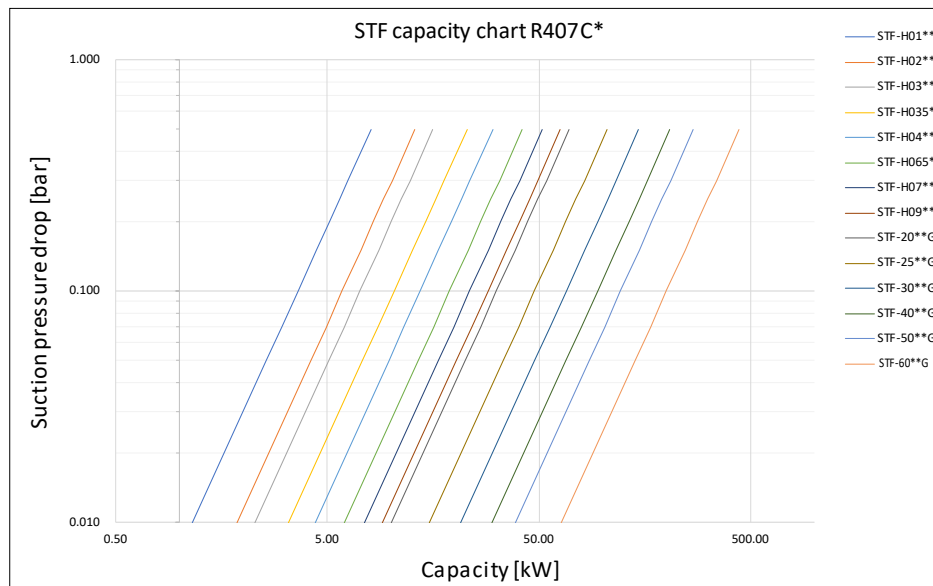

* Capacity calculated for CT 54.4 °C, ET 7.2 °C, SH 5K

Figure 7: STF capacity chart R410A

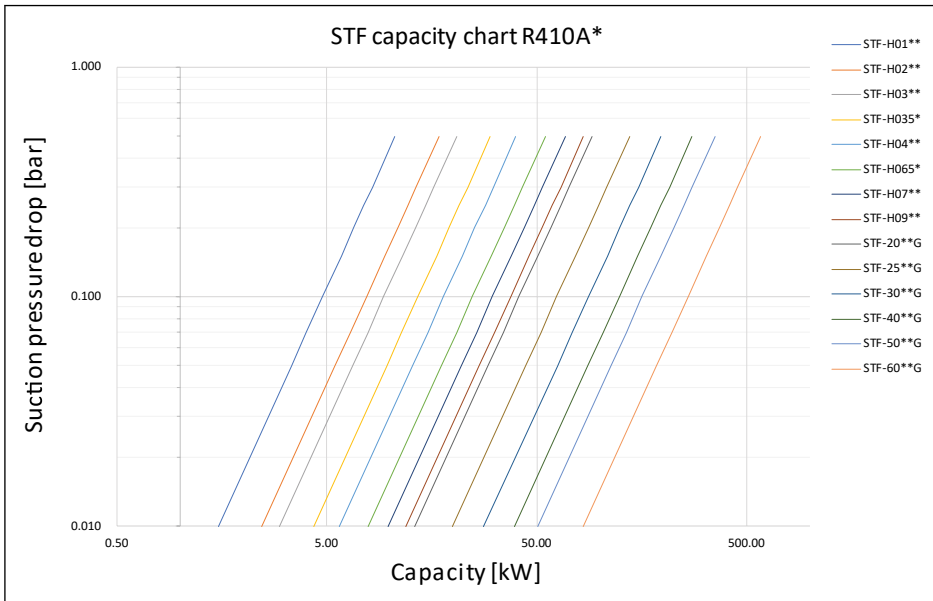

* Capacity calculated for CT 54.4 °C, ET 7.2 °C, SH 5K

Figure 8: STF capacity chart R448A

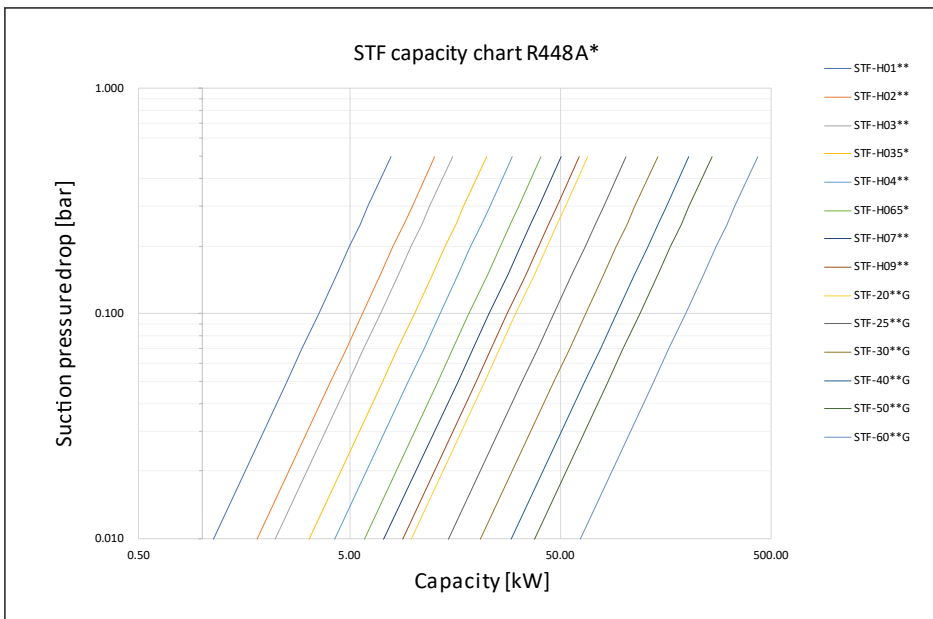

* Capacity calculated for CT 54.4 °C, ET 7.2 °C, SH 5K

Figure 9: STF capacity chart R449A

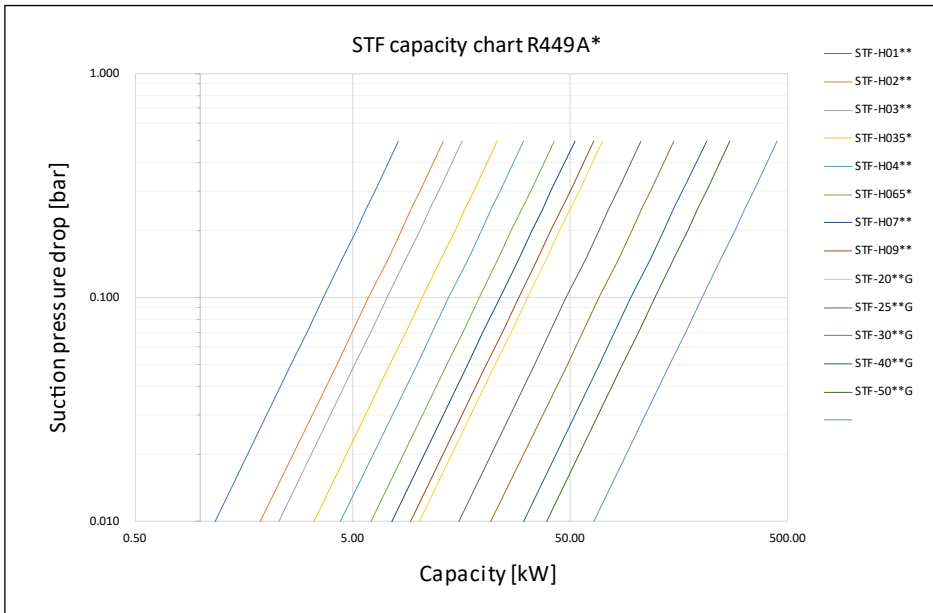

* Capacity calculated for CT 54.4 °C, ET 7.2 °C, SH 5K

Figure 10: STF capacity chart R32

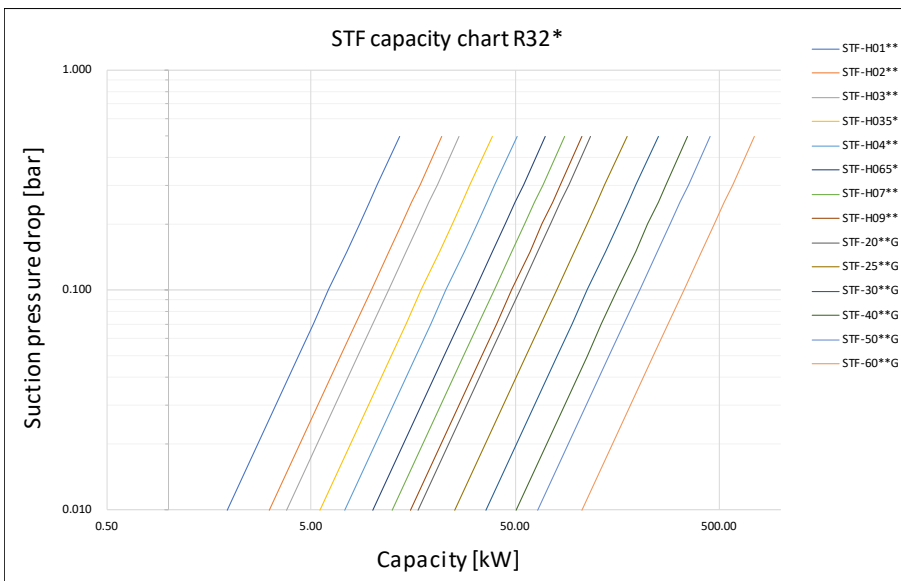

* Capacity calculated for CT 54.4 °C, ET 7.2 °C, SH 5K

Figure 11: STF capacity chart R290

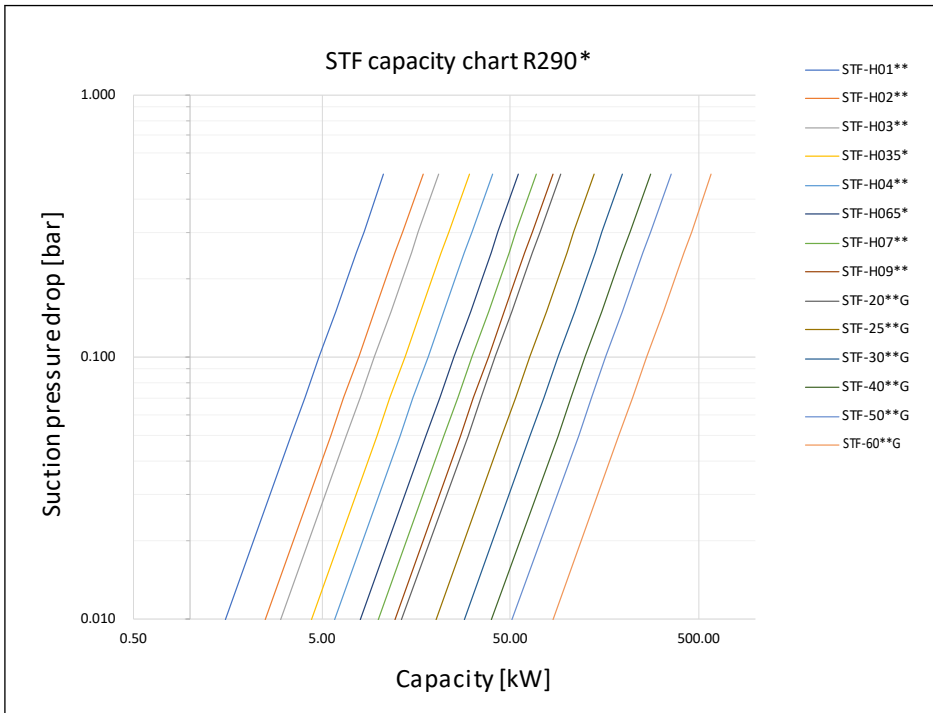

* Capacity calculated for CT 54.4 °C, ET 7.2 °C, SH 5K

Figure 12: STF capacity chart R452B

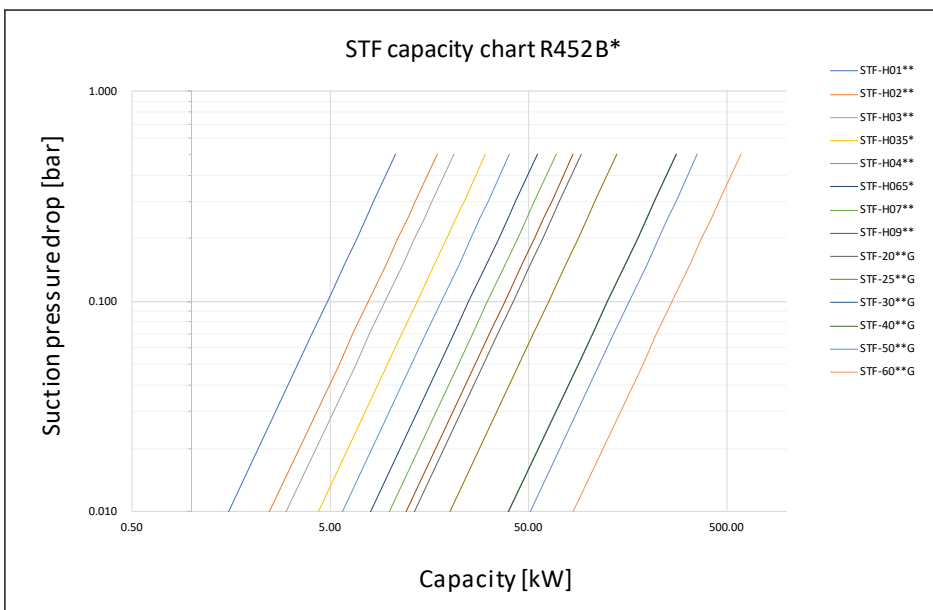

* Capacity calculated for CT 54.4 °C, ET 7.2 °C, SH 5K

Figure 13: STF capacity chart R454B

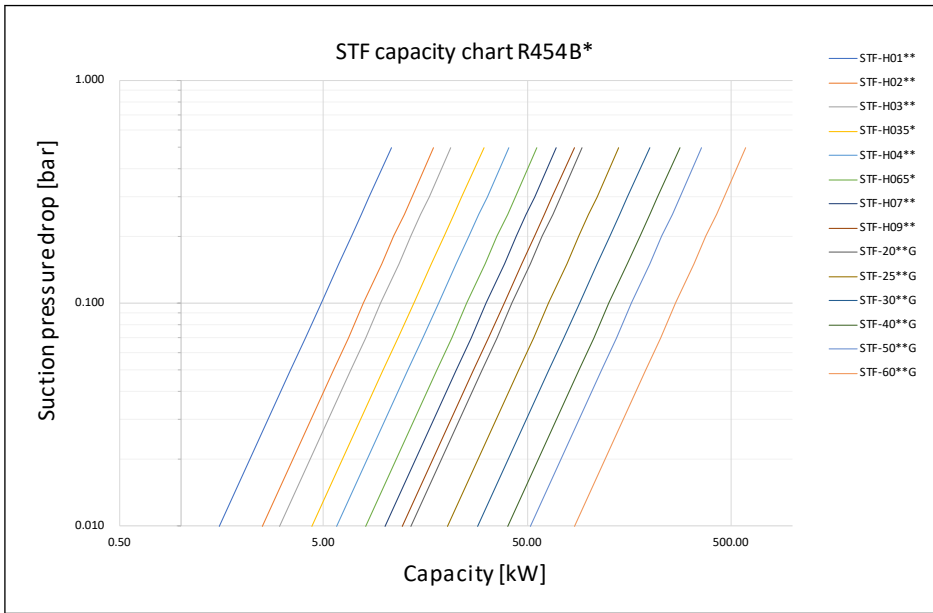

* Capacity calculated for CT 54.4 °C, ET 7.2 °C, SH 5K

Figure 14: STF capacity chart R454C

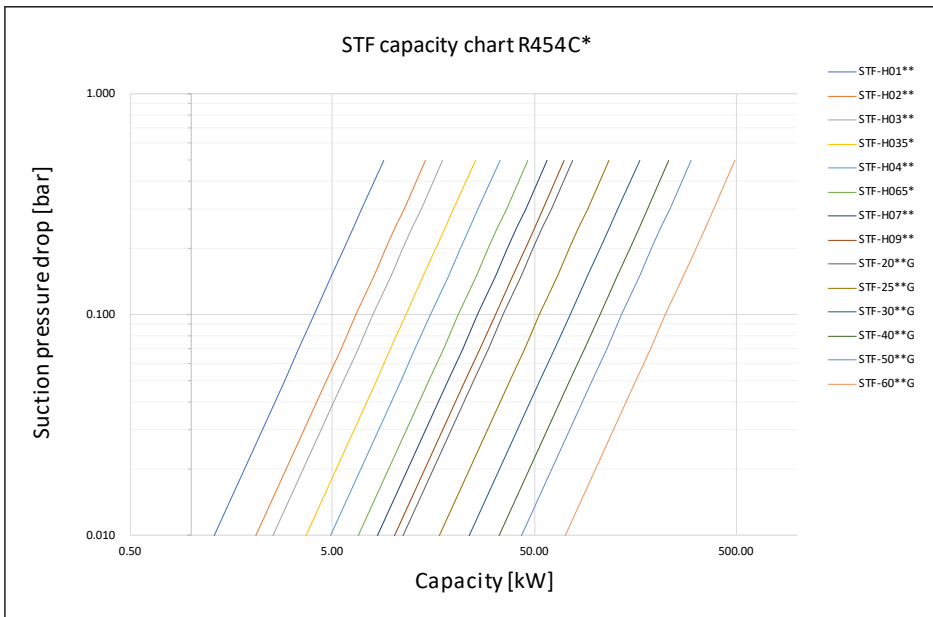

* Capacity calculated for CT 54.4 °C, ET 7.2 °C, SH 5K

NOTE:

For capacity charts for other refrigerants, please contact Danfoss.

Online support

Danfoss offers a wide range of support along with our products, including digital product information, software, mobile apps, and expert guidance. See the possibilities below.

The Danfoss Product Store



The Danfoss Product Store is your one-stop shop for everything product related—no matter where you are in the world or what area of the cooling industry you work in. Get quick access to essential information like product specs, code numbers, technical documentation, certifications, accessories, and more.

Start browsing at store.danfoss.com.

Find technical documentation



Find the technical documentation you need to get your project up and running. Get direct access to our official collection of data sheets, certificates and declarations, manuals and guides, 3D models and drawings, case stories, brochures, and much more.

Start searching now at www.danfoss.com/en/service-and-support/documentation.

Danfoss Learning



Danfoss Learning is a free online learning platform. It features courses and materials specifically designed to help engineers, installers, service technicians, and wholesalers better understand the products, applications, industry topics, and trends that will help you do your job better.

Create your Danfoss Learning account for free at www.danfoss.com/en/service-and-support/learning.

Get local information and support



Local Danfoss websites are the main sources for help and information about our company and products. Find product availability, get the latest regional news, or connect with a nearby expert—all in your own language.

Find your local Danfoss website here: www.danfoss.com/en/choose-region.

Spare Parts



Get access to the Danfoss spare parts and service kit catalog right from your smartphone. The app contains a wide range of components for air conditioning and refrigeration applications, such as valves, strainers, pressure switches, and sensors.

Download the Spare Parts app for free at www.danfoss.com/en/service-and-support/downloads.