

MARINE PRESSURE TRANSMITTER

Swiss based Trafag is a leading international supplier of high quality sensors and monitoring instruments for measurement of pressure and temperature. The economic pressure transmitter ECTN 8477 is based on the tried and true ECT line of transmitters. The wide media temperature range from -25 to 125°C in combination with a comprehensive set of features and options makes the ECTN 8477 pressure transmitter a versatile solution suitable for marine applications.



Applications

- Shipbuilding
- Engine manufacturing



Features

- Measuring ranges from 100 mbar
- Excellent media compatibility
- Relative or absolute pressure measurement
- Titanium version optional
- Frontal membrane optional

Technical Data			
Measuring principle	Thick-film-on-ceramic	Accuracy @ 25°C typ.	± 0.3 % FS typ. (± 0.5 % FS typ., ± 1 % FS typ.)
Measuring range	0 ... 0.1 to 0 ... 250 bar 0 ... 1.5 to 0 ... 3000 psi	Media temperature	-25°C ... +125°C
Output signal	4 ... 20 mA	Ambient temperature	-25°C ... +125°C
NLH @ 25°C (BSL) typ.	± 0.2 % FS typ. (± 0.3 % FS typ.)	Approval / conformity	DNV-GL EU RO Mutual Recognition Type Approval Certificate

08/2023

Data sheet H72322q

Subject to change

Ordering information/type code

Measuring range ¹⁾	Pressure measurement range [bar]	Over pressure [bar]	Burst pressure [bar]		8477 . XX								
					Pressure measurement range [psi]	Over pressure [psi]	Burst pressure [psi]						
	0 ... 0.1	1.2	2	66	0 ... 1.5	15	30	F6	XX	XX	XX	XX	XX
	0 ... 0.16	1.2	2	67	0 ... 2	15	30	F7					
	0 ... 0.2	1.2	2	68	0 ... 2.5	15	30	F8					
	0 ... 0.4	1.2	2	69	0 ... 5	15	30	F9					
	0 ... 0.6	2	3	70	0 ... 10	20	45	G0					
	0 ... 1.0	2	3	71	0 ... 15	30	45	G1					
	0 ... 1.6	3.2	4.8	73	0 ... 20	40	70	G3					
	0 ... 2.5	5	7.5	75	0 ... 30	60	90	G5					
	0 ... 4	8	12	76	0 ... 50	100	150	G6					
	0 ... 6	12	15	77	0 ... 100	200	250	G7					
	0 ... 10	20	25	78	0 ... 150	300	375	G8					
	0 ... 16	32	40	79	0 ... 250	500	625	G9					
	0 ... 25	50	75	80	0 ... 400	800	1200	H0					
	0 ... 40	80	100	81	0 ... 500	1000	1250	H1					
	0 ... 60	120	180	82	0 ... 1000	2000	3000	H2					
	0 ... 100 ⁴⁾	200	300	83	0 ... 1500 ⁴⁾	3000	4500	H3					
	0 ... 160 ⁴⁾	320	480	85	0 ... 2000 ⁴⁾	4000	6000	H5					
	0 ... 250 ⁴⁾	500	750	74	0 ... 3000 ⁴⁾	6000	9000	G4					
	Option 5P: Fivefold overpressure												
	0 ... 2.5	12.5	18	55									
	0 ... 4	20	30	56									
	0 ... 6	30	48	57									
	0 ... 10	50	75	58									
	0 ... 16	80	120	59									
	0 ... 25 ¹²⁾	125	180	60									
	0 ... 40 ¹²⁾	200	300	61									
	0 ... 60 ¹²⁾	300	480	62									
Sensor	with temperature compensation				without temperature compensation								
	Relative pressure, Material pressure connection and housing: 1.4404/1.4435 (AISI316L)			56	Relative pressure, Material pressure connection and housing: 1.4404/1.4435 (AISI316L) ¹⁰⁾			59					
	Relative pressure, Material pressure connection and housing: 1.4462 (AISI318LN) ⁴⁾			50	Relative pressure, Material pressure connection and housing: 1.4462 (AISI318LN) ^{4) 10)}			52					
	Relative pressure, Material pressure connection and housing: titanium grade 5 ⁴⁾			51	Relative pressure, Material pressure connection and housing: titanium grade 5 ^{4) 10)}			53					
	Absolute pressure, Material pressure connection and housing: 1.4404/1.4435 (AISI316L) ³⁾			86	Absolute pressure, Material pressure connection and housing: 1.4404/1.4435 (AISI316L) ^{3) 10)}			89					
	Absolute pressure, Material pressure connection and housing: 1.4462 (AISI318LN) ^{3) 4)}			80	Absolute pressure, Material pressure connection and housing: 1.4462 (AISI318LN) ^{3) 4) 10)}			82					
	Absolute pressure, Material pressure connection and housing: titanium grade 5 ^{3) 4)}			81	Absolute pressure, Material pressure connection and housing: titanium grade 5 ^{3) 4) 10)}			83					
Pressure connection	G1/4" female ⁴⁾								10				
	G1/4" male								17				
	G1/2" male DIN3852-A ⁴⁾								21				
	G1/2" male DIN3852-E ^{4) 13)}								41				
	1/4" NPT male ⁴⁾								30				
	7/16"-20UNF-2A male, SAE J1926-3 (Light Duty) ⁴⁾								42				
	R1/4" male, DIN3858								19				
	G3/4" frontal membrane ^{4) 6)}								52				

Electrical connection	Male electrical connector EN 175301-803-A, Mat. PA, -25°C ... +90°C				05
	Male electrical connector M12x1, 5-pole, Mat. PBT				35
	Cable Raychem, cable gland PA 6-3, -20°C ... +100°C ^{7) 8) 9)}				08
Output signal	Signal output	Load resistance	I (supply)	U (supply)	
	4 ... 20 mA	(U _{supply} -9 V) / 20 mA		9 ... 30 VDC	19
Accessories	Seal FKM (-20°C ... +125°C)				61
	Seal EPDM (-25°C ... +125°C)				63
	Female electrical plug EN 175301-803-A (DIN43650-A)/NBR, -40°C ... +90°C, for cable diameter 4 ... 9 mm, flammability standard UL94-V0				46
	Female electrical plug EN 175301-803-A (DIN 43650-A)/silicone, -40°C ... +125°C, for cable diameter 4 ... 9 mm, flammability standard UL94-V0				56
	Female electrical plug EN 175301-803-A (DIN43650-A)/NBR, -40°C ... +90°C, for cable diameter 4 ... 9.5 mm, flammability standard UL94-V2				58
	Female electrical plug M12x1, 5-pole				33
	Pressure peak damping element ø 0.4 mm, material 1.4404 ⁵⁾				44
	Pressure peak damping element ø 1.0 mm, material 1.4305 ⁵⁾				40
	Special electrical connection: Pin 1 +, Pin 2 - (only for output signal 4 ... 20 mA and male electrical connector EN175301-803-A / DIN43650-A)				92
	Special electrical connection: Pin 1 +, Pin 3 -, Pin 4 Ground (only for output signals 19 and male electrical connector 35, M12x1, 5-pole)				69
	Cable length 1.5 m				1M
	Cable length 3.0 m				3M
	Cable length 5.0 m				5M
	Housing nut for electrical connection EN175301-803-A (DIN43650-A) secured with Loctite (max. 85°C)				L9
	Multiple packaging ¹¹⁾				VM

¹⁾ Extended overpressure as well as customized pressure ranges upon request

³⁾ Absolute ranges max. 40 bar

⁴⁾ Upon request

⁵⁾ Not for pressure connections 10, 52

⁶⁾ Only with sensors 56, 50, 51, 86, 80, 81 (with temperature compensation) and for pressure ranges ≤ 25 bar or 400 psi

⁷⁾ Cable length see accessories (max. length 50 m, in 5-meter sections)

⁸⁾ IP68, max. 3 m, Media +10°C ... +35°C

⁹⁾ Cable length max. 3 m for pressure ranges ≤ 16 bar

¹⁰⁾ ≥ 1 bar

¹¹⁾ The order quantity must be a multiple of 50

¹²⁾ Only for sensors without temperature compensation

¹³⁾ Measuring range max. 350 bar according to SAE J1926-3 (Light Duty)

i Vacuum measuring ranges: Measuring ranges below 0 bar (e.g. -1 bar ... 0 bar) are available as special pressure ranges.
Reversed calibration: A reversed calibration is also possible for measuring ranges below 0 bar, with the signals 4 ... 20 mA (code 19), 1 ... 6 VDC (code 16) and 0 ... 10 VDC (code 17). The signal zero point is at 0 bar, the signal end point can be individually chosen between -1 bar and -0.1 bar. Additional configurations on request.

Standard products (extra short lead time)						
Product No.	Type Code	Pressure range [bar]	Over pressure max. [bar]	Signal output	Supply [VDC]	
ECTN1.0A	8477 71 5917 05 0000 0000 19 58 61	0 ... 1	2	4 ... 20 mA	9 ... 30	
ECTN2.5A	8477 75 5917 05 0000 0000 19 58 61	0 ... 2.5	5	4 ... 20 mA	9 ... 30	
ECTN4.0A	8477 76 5917 05 0000 0000 19 58 61	0 ... 4	8	4 ... 20 mA	9 ... 30	
ECTN6.0A	8477 77 5917 05 0000 0000 19 58 61	0 ... 6	12	4 ... 20 mA	9 ... 30	
ECTN10.0A	8477 78 5917 05 0000 0000 19 58 61	0 ... 10	20	4 ... 20 mA	9 ... 30	
ECTN16.0A	8477 79 5917 05 0000 0000 19 58 61	0 ... 16	32	4 ... 20 mA	9 ... 30	
ECTN25.0A	8477 80 5917 05 0000 0000 19 58 61	0 ... 25	50	4 ... 20 mA	9 ... 30	
ECTN40.0A	8477 81 5917 05 0000 0000 19 58 61	0 ... 40	80	4 ... 20 mA	9 ... 30	

Specifications		
Electrical Data	Output / supply voltage	4 ... 20 mA: 24 (9 ... 30) VDC
	Rise time	Typ. 1 ms / 10 ... 90 % nominal pressure
	Power-on delay time	100 ms
	Inverse-polarity protection, short-circuit strength @ 25°C during 5 min.	4...20 mA: to $U_s = 30$ VDC
Environmental conditions	Media temperature	-25°C ... +125°C
	Ambient temperature	-25°C ... +125°C
	Protection ¹⁾	IP65, IP67, IP68
	Humidity	IEC 60068-2-30 (damp heat, cyclic, 100 % RH @ +55°C)
	Vibration	20 g (10...2000 Hz)
	Shock	50 g / 3 ms
EMC Protection	Emission	EN/IEC 61000-6-3
	Immunity	EN/IEC 61000-6-2
Mechanical Data	Sensor (wetted parts)	Ceramic, Al ₂ O ₃ (96 %)
	Pressure connection (wetted parts)	59/89: 1.4404/1.4435 (AISI316L) 52/82: 1.4462 (AISI318LN) 53/83: Titanium Grade 5
	Housing	59/89: 1.4404/1.4435 (AISI316L) 52/82: 1.4462 (AISI318LN) 53/83: Titanium Grade 5
	Sealing	FKM 70 Sh, EPDM
	Male electrical connector	See ordering information
	Weight	~ 110 g
	Mounting torque	15...20 Nm

¹⁾ See electrical connection

Accuracy					
		Sensors 59/89/52/82/53/83		Sensors 56/86/50/80/51/81	
		Pressure measuring range	[bar]	≥ 0 ... 1	≥ 0 ... 0.3
	[psi]	≥ 0 ... 15	≥ 0 ... 5	≥ 0 ... 2.5 < 0 ... 5	≥ 0 ... 1.5 < 0 ... 2.5
TEB @ -25 ... +85°C	[% FS typ.]	± 3.0	± 1.0	± 2.0	± 3.0
Accuracy @ +25°C	[% FS typ.]	± 0.5	± 0.3	± 0.5	± 1.0
NLH @ +25°C (BSL)	[% FS typ.]	± 0.2	± 0.2	± 0.3	± 0.3
TC zero point and span	[% FS/K typ.]	± 0.03	± 0.02	± 0.02	± 0.02
Long term stability 1 year @ +25°C	[% FS typ.]	± 0.3	± 0.2	± 0.2	± 0.2

Sensors 56/86/50/80/51/81 0 ... 0.1 to 0 ... 0.16 bar

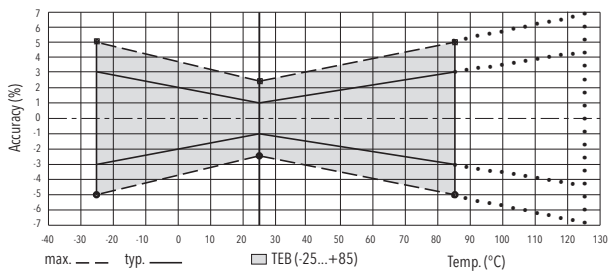

Sensors 56/86/50/80/51/81 0 ... 0.2 to 0 ... 0.4 bar

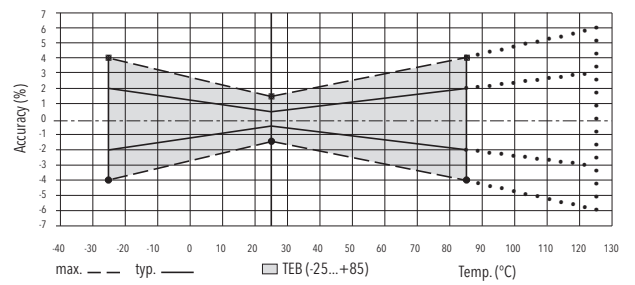

Sensors 56/86/50/80/51/81 > 0 ... 0.4 bar

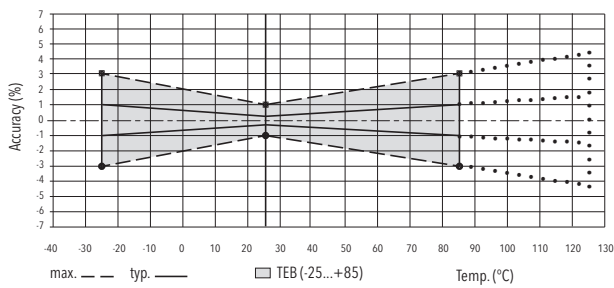

Sensors 59/89/52/82/53/83 ≥ 0 ... 1 bar

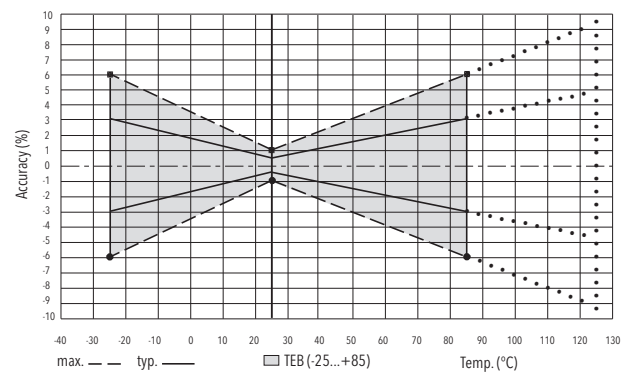

Dimensions

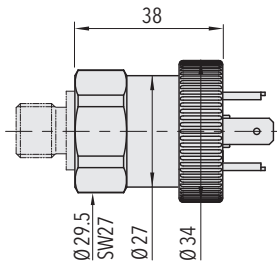

8477.XX.XXXX.05.XX.XX

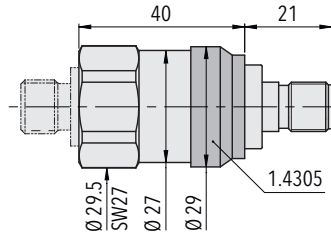

8477.XX.XXXX.35.XX.XX

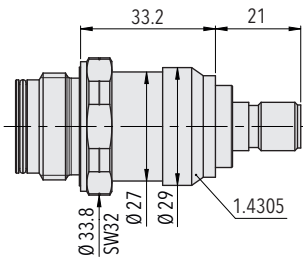

8477.XX.XX52.35.XX.XX

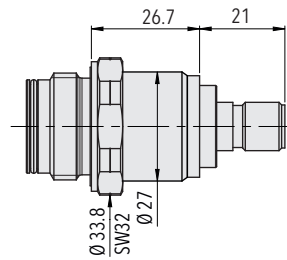

8477.XX.XX52.35.XX.XX

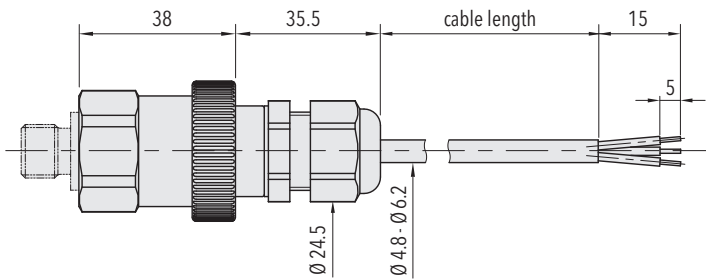

8477.XX.XXXX.08.XX.XX

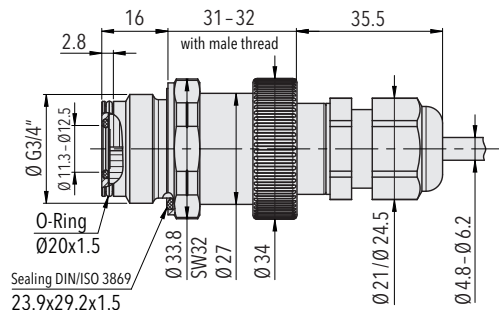

8477.XX.XX52.08.XX.XX

Dimensions

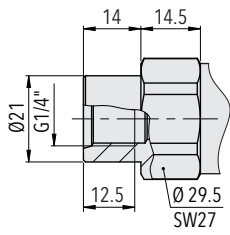

8477.XX.XX10.XX.XX.XX

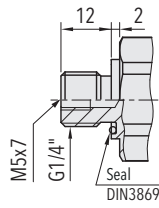

8477.XX.XX17.XX.XX.XX

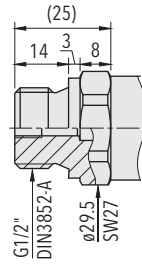

8477.XX.XX21.XX.XX.XX

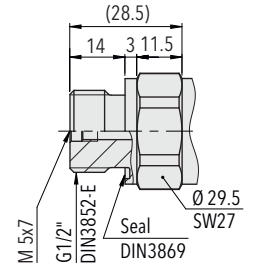

8477.XX.XX41.XX.XX.XX

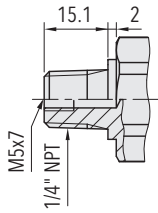

8477.XX.XX30.XX.XX.XX

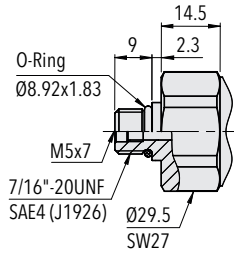

8477.XX.XX42.XX.XX.XX

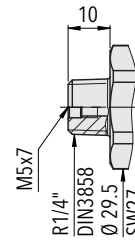

8477.XX.XX19.XX.XX.XX

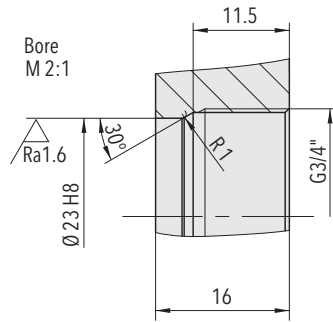

8477.XX.XX52.05.XX.XX

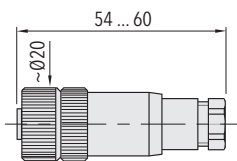
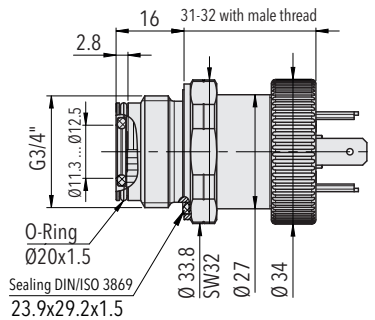

8477.XX.XXXX.XX.XX.33

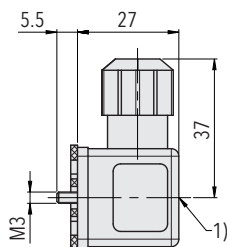

1) Tightening torque 50...60 Ncm

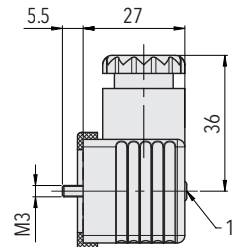

8477.XX.XXXX.XX.XX.46/56



1) Tightening torque 50...60 Ncm

8477.XX.XXXX.XX.XX.58

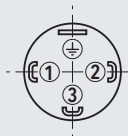
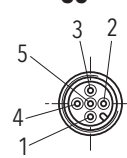
Electrical connection

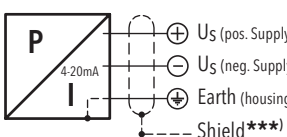
		Protection / electrical connection			
		IP65 ^{*)}	IP67 ^{*)}	IP68 max. 3 m	
		Industrial standard EN175301-803A ^{**)}	M12x1 ^{**)} 5-pole	Cable ^{**)}	
		05	35	08	
					
Output signal		Standard	92	G9	
	8477.xx.xxxx.xx.19	2 1 ⊕	1 2 ⊕	4 1 5	1 3 4

^{*)} Provided female electrical plug is mounted according to instructions

^{**)} Ventilation via male electric plug/cable end

^{***)} Only cable versions or female electrical plug with shield connection

Additional information

Documents

Data sheet	www.trafag.com/H72322
Instructions	www.trafag.com/H73324
Flyer	www.trafag.com/H70688